Application Ref: NP/12/0412

Application Type	Full
Grid Ref:	SM78572509
Applicant	Mr & Mrs A Malein
Agent	Mr C Kimpton, CK Planning
Proposal	Renovation of existing former farm workers (dwelling) cottage to create a rural enterprise workers dwelling
Site Location	Penpant, Nine Wells, Haverfordwest, Pembrokeshire, SA62 6UH
Case Officer	Liam Jones

Summary

This application proposes the conversion of an existing farm building at Pen Pant Farm in Solva into a rural enterprise workers dwelling. Planning Policy Wales and Technical Advice Note 6: Planning for Sustainable Rural Communities provide the basis for assessing such applications proposing new agricultural dwellings in the open countryside.

The application shows proposals to transfer the management of the farm to the applicant's daughter which will encourage a younger person to manage the farm business and promote the diversification of established farms in accordance with the principles of National Policy. However the Policy sets out clear tests to be satisfied in order to establish a genuine need for a new dwelling in the open countryside. In this instance it is recognised that the farm is long established but less clear that the business is planned on a financially sound basis to meet the criteria set out in Technical Advice Note 6. Figures provided by the applicant to the Authority show that the profits of the business have declined significantly since 2008 and this is material to the consideration of the application. The Authority's Agricultural Advisor states that the granting of planning consent for an additional dwelling in this instance could be premature as there is a significant risk that the business could continue to decline in future years.

In view of the lack of a clear justification that the business is profitable and will grow into the future upon grant of planning permission there is clear conflict with Technical Advice Note 6: Planning for Sustainable Rural Communities which states that the enterprise and the business need for the job needs to be '*currently financially sound and has a clear prospect of remaining so*'. In this instance the current enterprise is not financially sound and whilst the change in management may help the business there is no 'clear prospect' that it will work and succeed. Concerns have also been raised by the Agricultural Advisor in respect of the functional need for a person to live on the farm in view of the small scale nature of this arable farming business. Full consideration has not been given by the applicant to the implementation of onsite security in order to negate the need for a new additional dwelling on the site.

Officers have advised the applicant that in order to justify a need for a new dwelling at the site it would be prudent to seek a temporary planning permission for a mobile home. This would allow the transfer of the business to take place and also allow the business to expand over the coming years (usually on a 3 years basis) to produce evidence of larger profits which are needed to justify a new second dwelling in the open countryside.

Accordingly the scheme as submitted fails to meet the tests set out by National Policy and Guidance and therefore fails to comply with Policy 7 of the Adopted Local Development Plan. As such the scheme is recommended for refusal.

The application is brought to the Development Management Committee as St David's City Council's recommendation for approval runs contrary to officer's recommendation to refuse the scheme.

Consultee Response

Carmarthenshire County Council Estates: Objecting - recommend refusal.

St Davids City Council: It was resolved that the Clerk would attend the meeting of the Development Control Committee and confirm the City Council's full support of the application.

St Davids City Council: No objection - support

Dwr Cymru Welsh Water: No objection

Ecologist - Pembrokeshire County Council: No objection

Environment Agency Wales: No objection - subject to informative

PCC - Transportation & Environment: No objection - subject to conditions.

PCC- Building Regulations: No objection

Public Response

The application was advertised by a site notice displayed at the site access on 5th September 2012. Letters were forwarded to the nearest neighbours to the site at Haulfryn, Delfryn and Glenview.

To date one letter of representation has been received from the occupier of Haulfryn. The letter raises concerns about vehicle movements around the proposed dwelling, concerns that the dwelling would be used for holiday accommodation rather than a workers dwelling with impact upon family life including noise, greater levels of traffic and reduction in privacy.

Policies considered

Please note that these policies can be viewed on the Policies page Pembrokehire Coast National Park website - <http://www.pembrokeshirecoast.org.uk/default.asp?PID=549>

LDP Policy 01 - National Park Purposes and Duty
LDP Policy 07 - Countryside
LDP Policy 08 - Special Qualities
LDP Policy 11 - Protection of Biodiversity
LDP Policy 15 - Conservation of the Pembrokehire Coast National Park
LDP Policy 29 - Sustainable Design
LDP Policy 30 - Amenity
LDP Policy 31 - Minimising Waste
LDP Policy 32 - Surface Water Drainage
LDP Policy 42 - Employment Sites and Live/Work Units
LDP Policy 44 - Housing
LDP Policy 45 – Affordable housing
LDP Policy 53 - Impacts on traffic
PPW5 Chapter 03 - Making and Enforcing Planning Decisions
PPW5 Chapter 04 - Planning for Sustainability
PPW5 Chapter 05 - Conserving and Improving Natural Heritage and the Coast
PPW5 Chapter 07 - Economic Development
PPW5 Chapter 09 - Housing
SPG04 - Planning Obligations
SPG05 - Sustainable Design
SPG06 - Landscape
TAN 05 - Nature Conservation and Planning
TAN 06 - Planning for Sustainable Rural Communities
TAN 12 - Design

Officer's Appraisal

Background

The application site relates to Pen Pant Farm, a working small scale arable farm located west of Solva.

The site has been subject to a number of planning applications in recent years proposing the conversion of the building subject of this application into holiday accommodation as well as a dwelling. The applications, as detailed below, were refused primarily because the building was not considered to be suitable

for conversion in that it was not considered to make a positive contribution to the local character of the area.

History

NP/10/138 – Penpant Farm, Solva – Reinstatement of original cottage currently used as outbuilding to dwelling – Refused – 17 June 2010

NP/09/462 – Penpant Farm, Solva – Reinstatement of original cottage – Withdrawn – 17 November 2009

NP/08/216 – Penpant Farm, Solva – Reinstatement of dwelling – Refused – 16 October 2008

NP/07/508 – Penpant Farm, Solva – Change of use Outbuilding to Holiday Accommodation – Refused – 22 January 2008

NP/06/468 – Penpant Farm, Solva – Change of use Outbuilding to Holiday Accommodation – Withdrawn – 13 November 2006

Constraints

- Biodiversity Issue
- Historic Landscape

Current proposal

The application proposes the conversion of an existing storage building at the farm complex into a rural enterprise workers dwelling. The application forms describe this as involving renovation of an 'existing' farm workers cottage to create a rural enterprise workers dwelling although the forms also state that residential use of the cottage ceased in the 1940's.

The works proposed include the provision of a light weight metal umbrella designed to sit on top of the original stone cottage and supported by timber posts, a new extension to be clad in timber boarding along the south elevation, re-pointing of existing stone walls and finished in lime render.

Internal accommodation proposed comprises an open-plan kitchen, dining and living room on the ground floor in the main part of the building, a snug/future bedroom in a small flat roof extension and a utility room, shower room and entrance porch provided in the new single storey extension. The first floor comprises two bedrooms and a bathroom.

The application has been supported by the following submissions:

- Planning Report
- Design and Access Statement
- Financial Statements for the year 2002 to 2012
- Bat and Barn Owl Survey

- Transport Statement
- Structural Report

The supporting information states that the holding comprises 20ha although it has been established that only 12 acres are presently being farmed by the applicants. The site is used for growing seasonal vegetables such as leeks, potatoes, beetroot, parsnips etc.. One part time worker (3 days a week) is employed in addition to the applicant's Mr and Mrs Malein.

Key Issues

The application raises the following planning matters:

- Principle of Development
- Agricultural Justification
- Visual Amenity and the Special Qualities of the National Park
- Access, Parking and Highway Safety
- Neighbouring Amenity
- Protected Species

Principle of development

The site lies within a countryside location and outside a recognised Centre in the Local Development Plan ('LDP'). New residential uses are generally restricted to Centres in order to prevent uncontrolled and sporadic development in the countryside although provision is made through the LDP and Policy 7 for housing where it can be demonstrated to meet essential farming or forestry needs.

Applications for planning permission for a second dwelling on an established farm need to be carefully assessed to ensure that a departure from the usual policy of restricting development in the open countryside can be fully justified by reference to robust supporting evidence. Such schemes can be judged against the stringent criteria as set out in Technical Advice Note 6: Planning for Sustainable Rural Communities (TAN 6) (July 2010) as well as the Practice Guidance Document: Rural Enterprise Dwellings (December 2011).

New dwellings on established rural enterprises should only be allowed where there is a functional need, a requirement for an additional full-time worker, it passes financial requirements, the functional need could not be fulfilled by another dwelling or buildings capable of conversion and other normal planning requirements are satisfied.

It is clear from the site and proposals that there is an existing dwelling serving Pen Pant farm which is occupied by the applicants. The scheme therefore involves the alteration/renovation of a separate and existing farm storage building at the site to provide for a farm workers dwelling for the applicant's daughter to reside in independently at Pen Pant Farm after taking over running the business.

A draft legally binding agreement has been submitted which states that the overall management of Pen Pant Farm would be taken over by the applicant's daughter upon grant of planning permission and a Rural Enterprise Dwelling Appraisal has been submitted within the Planning Report. The supporting documents submitted state that there exists a clear functional and financial support for the proposals and consideration therefore needs to be given to the tests set out in TAN6.

Agricultural Justification

Paragraph 4.5.1 of Technical Advice Note 6 states *"the Assembly Government wishes to encourage younger people to manage farm business and promote the diversification of established farms. To support this policy objective it may be appropriate to allow a second dwelling on established farms that are financially sustainable where the criteria (a to e) set out in paragraph 4.4.1 cannot be fully sustained"*. Criterion (a) refers to there being a clear established existing functional need and criterion (b) refers to a full-time worker and not a part-time requirement.

The paragraph goes on to identify two exceptions to the policy as follows:

- Where there are secure and legally binding arrangements in place to demonstrate that management of the farm business has been transferred to a person younger than the person currently responsible for management, or, that transfer of management is only conditional upon grant of planning permission for the dwelling. The younger person should demonstrate majority control over the farm business and be the decision maker for the farm business;
- or,
- There is an existing functional need for an additional 0.5 or more of a full time worker and that person obtains at least 50% of a Grade 2 Standard Worker salary, (as defined by the latest version of the Agricultural Wages Order), from the farm business.

Any planning application for the provision of a second dwelling on an established farm therefore has to satisfy either one of the abovementioned provisions. Paragraph 4.5.2 of TAN 6 then goes on to say that *"in these circumstances a rural enterprise dwelling may be considered favourably provided the criteria set out in paragraph 4.4.1 c – e are met. These special policy exceptions will only apply to the first additional dwelling to be attached to an established farm after this TAN comes into force and not to subsequent dwellings."* Paragraph 4.5.3 sets out additional caveats and states *"it must also be demonstrated that the management successor or part time worker is critical to the continued success of the farm business, and that the need cannot be met in any other reasonable way, e.g. through the re-organisation of labour responsibilities. In addition, where all the criteria specified above are*

met the planning authority should ensure that the new dwelling is tied to the holding by way of a legal agreement”.

In this instance the applicant's have submitted a draft legally binding agreement showing the transfer of the farm business from the applicants Mr Andrew Malein and Mrs Marlis Malein to their daughter Ms Erika Malein dated 6th August 2012 to take effect upon grant of planning permission for the development proposals. As such the proposal meets with the first criteria mentioned above subject to provision of a legal agreement.

The criteria as set out in paragraph 4.4.1 (c) to (e) mentioned above to be met are as follows:

- c) the enterprise concerned has been established for at least three years, profitable for at least one of them and both the enterprise and the business need for the job, is currently financially sound, and has a clear prospect of remaining so;
- d) the functional need could not be fulfilled by another dwelling or by converting an existing suitable building already on the land holding comprising the enterprise, or any other existing accommodation in the locality which is suitable and available for occupation by the worker concerned;
- e) other normal planning requirements, for example siting and access, are satisfied.

Planning Policy Wales (4th Edition 2011) stipulates at paragraph 9.3.10 that *“Applications for rural enterprise dwellings must only be permitted where the rural enterprise dwelling appraisal provides conclusive evidence of the need for the dwelling and an occupancy condition is applied.”*

Criterion (c) - Financial Test

The financial test as set out in the TAN explains that *“the rural enterprise and the activity concerned should be financially sound and should have good prospects of remaining economically sustainable for a reasonable period of time, usually at least 5 years”*. It goes on to say that evidence of actual or potential economic performance will be required as well as information that the business has a reasonable prospect of providing a market return for all operators at the site.

The financial test performs two functions. Firstly, it seeks to establish whether an existing or proposed rural enterprise is sustainable when viewed in the immediate short-term. If this cannot be demonstrated, it is unlikely that planning permission will be granted for a dwelling, even if there is currently a functional need to house a worker, as that need is unlikely to be sustained.

Secondly, the test assesses whether the size and cost of a proposed dwelling is commensurate with the ability of the enterprise to fund and sustain it without prejudice to the continued viability of the enterprise.

The Welsh Government issued Practice Guidance in December 2011 which indicates that where dwelling proposals relate to existing enterprises, it will be possible and necessary to provide information over a minimum of three past consecutive years to appraise their actual financial soundness. The application has been supported by financial records for Pen Pant Farm covering the period 2002 to 2012 with the net profit being summarised in Figure 1 below.

Year	2002	2003	2004	2005	2006	2007	2008	2009	2010	2011	2012
Net Profit £'s	20,806	17,879	26,567	19,001	14,382	11,601	12,676	3,523	5,616	874	5,279

Figure 1: Extract from applicant's Planning Report, page 13

The figures show that the farm has been economically sustainable over the majority of this time although in recent years, and particularly since 2008, profits have severely suffered. The supporting information states that the declining profits in recent years is related to the applicant's ages (now 72 yrs and 69 yrs), ongoing health problems as well as particularly cold winter months of December 2010 through to March 2011. The report states that the applicants have been operating from Pen Pant for the past 42 years and the farm has been economically sustainable. It further advises that Pen Pant Farm is well known to locals and thousands of visitors for its unique farm shop, quality and cost of produce and friendly welcome by the applicants.

The Authority's Agricultural Advisor states that although the applicant's envisage the business along with profits will grow once management has changed hands this is speculation. Granting permission for an additional permanent dwelling at the site could be premature as there is a significant risk that the business could continue to decline in future years.

The lack of any clear justification that this business is profitable and will grow into the future upon grant of planning permission so as to remain economically sustainable represents a clear conflict with criterion (c) of paragraph 4.4.1 of TAN 6 which states that the enterprise and the business need for the job needs to be '*currently financially sound and has a clear prospect of remaining so*'. In this instance the current enterprise is not financially sound and whilst the change in management may help the business there is no 'clear prospect' that it will work and succeed.

In view of the above the applicant has been advised that the Authority may look favourably on a temporary planning permission for a caravan or mobile home in order to allow the business to expand over the next years. This would be in accordance with Planning Policy Wales (Edition 4, February 2011) paragraph 9.3.8 to establish that the rural enterprise is capable of being sustained for a reasonable period and there is a proven need. Such permission, usually granted for a period of 3 years, would allow the finances

of the business and profits to grow as a result of the change in management to attempt to meet the financial test set out by Policy. To date not such application has been made.

Criterion (d) - Other Accommodation Test

This criterion refers to the 'Other Dwelling Test' contained in TAN6 and explains that evidence must be provided to demonstrate that there is no other dwelling or buildings suitable for conversion or other accommodation in the locality which is suitable and available for occupation to meet the need. The Practice Guidance to TAN6 states at paragraph 6.10; *"in relation to the special case of the transfer of management of farming enterprises to the younger generation, the general requirement to address alternative housing options still applies, as does the need to explore alternative management approaches which might avoid the need for an additional dwelling"*.

In this instance it is accepted that the application is to convert an existing farm building to accommodation although the applicant has not fully explored the alternative housing options away from the site or alternative management approaches which could avoid the need for the creation of an additional dwelling.

With regard to other available dwellings in the locality the applicant states that average house prices are in the region of £250,000 to £350,000 whilst long term rentals, if available, are in the region of £500 to £650 a month. As such the farm business cannot afford to compete in the local housing market due to the attractiveness of the area and popularity for holiday and second homes. Whilst the housing market is noted, on production of this report there are two dwellinghouses for sale within 1km of the site at Bro Dawel, Solva which are priced at £132,500 and £134,995 respectively.

Within the application it is stated that there is a need for someone to be on site for security, maintenance and monitoring of farm irrigation systems, pest control, running of the farm shop and the ability to respond to changing weather. It is debatable, however, whether there is an actual functional need for someone to be at the site at all times to cater for the needs of this small business. Technical Advice Note 6, paragraph 4.8.1, outlines that the functional test is necessary to establish whether it is 'essential' for the proper functioning of the enterprise, for one or more workers to be readily available at most times. This should be related to unexpected situations and usually to deal with emergencies that would threaten the continued viability and existence of the enterprise without immediate action. The Authority's Agricultural Advisor explains that the functional need requirement would usually only be met by matters such as calving cows where an emergency out of hours requirement is a regular occurrence.

With regard to security on the farm it is accepted that living remotely could impact upon security, however, the use of modern technology which can be achieved remotely through means such as CCTV and temperature and other environmental sensors has not been fully explored. The applicant advises that

the business would not sustain the level of capital expenditure needed to purchase modern high tech security and irrigation equipment although the conversion of a farm building to a residential use would require a far higher investment than the majority of security systems available to meet the need. The siting of a farm shop at the premises is noted and although open at all times it operates on an 'honesty box' which only makes between 5- 10% of the farms income given that they concentrate on the whole sale market rather than retail.

In view of the above the applicant has failed to demonstrate a clear functional need to reside on the site and has not explored additional options particularly in housing and management of the farm to prevent the need for a new dwelling. Whilst the TAN in relation to second dwellings omits the general requirement to meet a 'functional' test (Paragraph 4.5.2) it also makes clear that all other avenues should be explored before allowing an exception to policy. The concerns raised by the Authority's Agricultural Advisor add weight to the concern regarding the financial credentials of the business.

Criterion (e) - Other Normal Planning Requirements

The final considerations relate to normal planning requirements which, in this instance, include the siting, design, appearance, impact upon visual amenity and the special qualities of the National Park, access, parking and highway safety as well as any impact upon protected species and the water environment.

Visual Amenity and the Special Qualities of the National Park

Policy 15 of the Pembrokeshire Coast National Park Local Development Plan (LDP) seeks the conservation of the Pembrokeshire Coast National Park with criteria 'a' and 'b' resisting development that would cause significant visual intrusion and/or, that would be insensitively and unsympathetically sited within the landscape. Policy 30 of the LDP seeks to avoid development that is of an incompatible scale with its surroundings (criterion 'b') or is visually intrusive (criterion 'd').

The building proposed for conversion has not been held to be an acceptable building for conversion to a full residential or holiday letting unit in previous application submissions (NP/08/216, NP/07/508 and NP/10/138). These decisions were based on the poor design proposed and the existing building not being one which would make a positive contribution to the character of the local area such that it would qualify as a conversion opportunity. The design of the building has been altered significantly since the previous refusals.

Notwithstanding the previous unacceptability of proposals to convert the building on site the TAN states that the rural enterprise dwelling should satisfy usual planning requirements. The Practice Guidance states that prominent buildings should be avoided, it should be functional to the needs of the farm, its design should achieve minimum sustainable building standards and should be of a scale to reflect the needs of the enterprise. Whilst these factors would

usually relate to new dwellings in a new building it is reasonable that the same factors are applied to a conversion.

The design of the dwelling is reflective to that of the existing building and there are no significant alterations to its scale or form with the only small extension along the south elevation. Given the siting of the building within the complex and it being set behind an existing two storey property (Haulfryn) there will not likely be any adverse harm upon surrounding visual amenities. The use of a mixture of traditional limewashed stonework, timber doors and windows and a more modern zinc roof adds variety and interest to the building. In view of this there would be no demonstrable harm to the surrounding landscape and subject to suitable conditions controlling the use of materials the scheme would comply with the aims of policies 15 and 30 of the LDP. However, these considerations are only pertinent where the basic principle of a farm dwelling is supported and should not override an objection to the principle of the development.

Access, Parking and Highway Safety

The proposed dwelling would utilise the existing access and parking facilities and no changes are sought. The Highway Authority has been consulted and note that visibility at the existing access point with the A-class county road is restricted by some existing hedgebank growth/overgrowth when looking towards the north west (St Davids). Visibility looking towards the south east (Solva) is restricted by the height of the existing hedgebank, growth and several trees. The notes state that approximately 12m of the hedge growth towards the south east will need altering and the height of hedgebank will need to be reduced to no higher than 900mm.

With no objection to the principle of the scheme the Highway Authority recommend the imposition of suitable conditions to require visibility splays be provided and no growth or obstruction be imposed. With regard to parking and access plans show there is adequate space available on site to serve the dwelling. As such the scheme, subject to suitable conditions, would be acceptable on the grounds of access, parking and highway safety. Again however, these considerations are only pertinent where the basic principle of a farm dwelling is supported and should not override an objection to the principle of the development.

Neighbouring Amenity

One letter of representation has been received. The letter received states that there are concerns that if the building did get renovated it could be used for holiday accommodation rather than a workers dwelling which would raise noise levels, traffic and reduce privacy at the property. No specific objection to the scheme is quoted and whilst these concerns are relevant they relate to concerns regarding holiday accommodation as opposed to the rural enterprise dwelling applied for.

The dwelling is proposed alongside an existing residential unit not within the ownership of the applicants, Haulfryn. Whilst accepting that the change in use of the building from agricultural storage to an agricultural workers dwelling will increase access and movement around the property there would not be sufficient grounds to withhold planning permission on the basis of impact of the dwelling upon the neighbouring occupier. The dwelling proposed is sited close to the boundary with Haulfryn although would not represent an unacceptable intrusion in visual terms, be an overbearing development or cause an increase in traffic, noise, odour or light which has a significant adverse impact. As such the scheme complies with the aims of Policy 30 of the LDP. Again however, these considerations are only pertinent where the basic principle of a farm dwelling is supported and should not override an objection to the principle of the development.

Protected Species

A protected species survey submitted with the application which shows that a scoping survey was carried out in March 2012 and two activity surveys in May 2012. The survey recorded the use of the building by bats under the roof in the north west corner. Bats were also recorded feeding and commuting along the western end of the building benefitting from a sheltered flight area.

Mitigation is shown to include three bat tubes on the south and west elevation and one box on the west elevation. The surveyor has also recommended that due to the disruption of the work bat boxes are put up around the site whilst the works are ongoing. The Authority's Ecology Advisor raises no objection to this arrangement and that the works should be carried out in line with the recommendations of the Bat and Barn Owl Survey dated June 2012. Subject to suitable conditions, including controlling any external lighting the scheme would comply with the aims of Policy 11 of the LDP.

Conclusion

In conclusion, whilst the application would allow the applicants to transfer the control of the business to a younger person in the spirit of the aims of Technical Advice Note 6 there is insufficient justification at present to prove that the business is planned on a sound and profitable basis and that it will continue to grow into the future, so as to remain economically sustainable. This coupled with concerns regarding the lack of exploration of other options to improve the management of the farm provide a reasoned basis to refuse planning permission despite the acceptability of the application on other material planning considerations.

As such the application fails to demonstrate robust and conclusive evidence that the business is planned on a sound basis to warrant approval of a new dwelling. The scheme runs contrary to the key points highlighted by the Welsh Government Practice Guidance: Rural Enterprise Dwellings, with one being that; *"the basis of rural housing policy is that every opportunity should be examined to avoid the creation of new residential development in the countryside"* (page 32). The scheme therefore fails to meet the tests as set

out in Technical Advice Note 6: Planning for Sustainable Rural Communities and Policy 7 of the Adopted Pembrokeshire Coast National Park Local Development Plan.

Recommendation

The application be refused for the following reasons:

Reasons:

1. The application fails to conclusively demonstrate that the enterprise is financially sound and has a clear prospect of remaining so into the future in order to ensure economical sustainability and justify a second dwelling at Pen Pant Farm. As such the proposal has not been demonstrated as being essential to farming and is contrary to Policy 7 of the Pembrokeshire Coast National Park Local Development Plan (Adopted September 2010) and paragraph 4.4.1 (c) and Section 4.10 of Technical Advice Note 6: Planning for Sustainable Rural Communities (July 2010).
2. The application fails to show that all alternative housing and other management approaches have been considered which might avoid the need for the creation of an additional dwelling. As such the proposal is contrary to Policy 7 of the Pembrokeshire Coast National Park Local Development Plan (Adopted September 2010) and advice provided in Welsh Government Practice Guidance – Rural Enterprise Dwellings (December 2011) paragraph 6.10 and Technical Advice Note 6: Planning for Sustainable Rural Communities (July 2010).



© Crown Copyright. All rights reserved. Licence no. 100019980

Proposed existing former farm workers cottage to create a Rural Enterprise Workers Dwelling

12412

08 AUG 2012

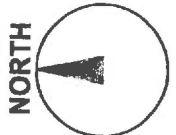

ckplanning
 Chris Kimpson
 BA(HONS) MRTPI
 Chartered Town Planner

NP/12/0412

01348 872352
 0789 614 3152

Client: Andrew & Mairis Maleh
 Job: Renovation of an Existing Corner Farm Workers (Dwelling) Cottage to Create a Rural Enterprise Workers Dwelling
 Drawing: Location Plan
 Date: 1:1280 Issue: RC Date: May 12

NOTE: THESE DRAWINGS ARE FOR INFORMATION ONLY. NO LIABILITY IS ACCEPTED FOR ANY CONSEQUENCES ARISING FROM THE USE OF THESE DRAWINGS. THE CLIENT IS RESPONSIBLE FOR OBTAINING ALL NECESSARY CONSENTS AND FOR THE ACCURACY OF THE INFORMATION PROVIDED.

South Elevation

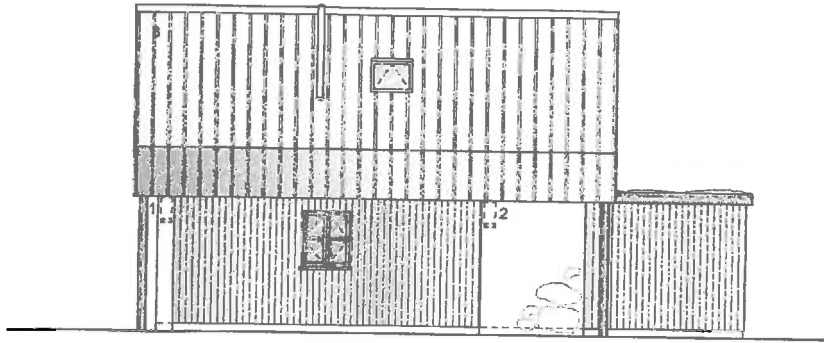

NP/12/0412

- 1 - Schwegler 2FR bat tube
- 2 - Schwegler 2FR bat tube

North Elevation

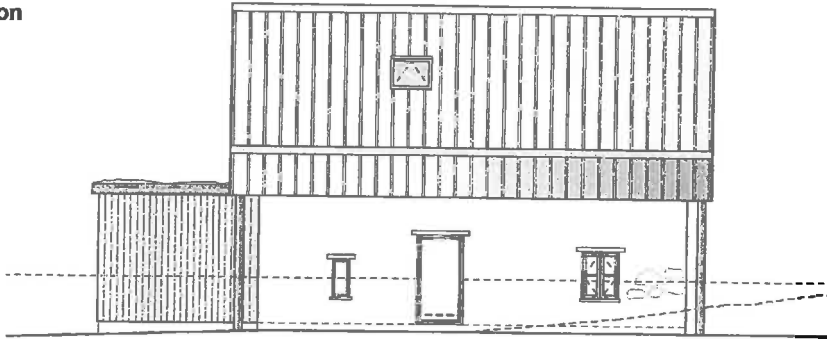

East Elevation

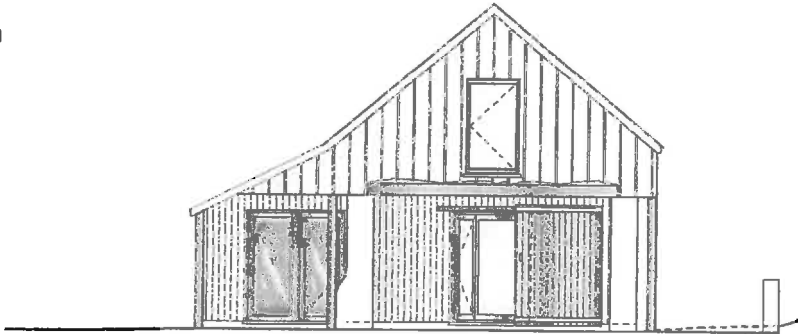

West Elevation

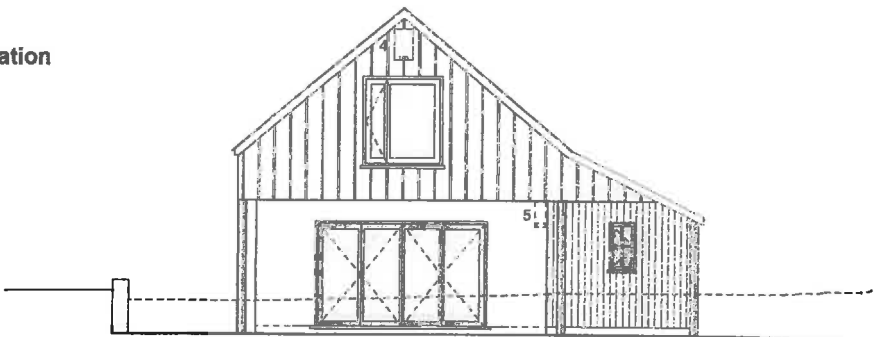

- 4 - Schwegler 1FQ bat box
- 5 - Schwegler 2FR bat tube

08 AUG 2012

at Mitigation:

A full Bat Survey and Method Statement has been undertaken by licensed bat surveyor BW Batwork and has been submitted as part of this planning application. Key mitigation measures have been shown on the drawings and are summarised below. They should be read in conjunction with the full report for more detailed information and advice.

- External Lighting must be of a downward lit type and not located within close proximity to bat access points
- 3 No. Schwegler 2FR bat tubes will be incorporated into the new cavity walls and will be disguised by the proposed rendered stonework (See locations 1, 2 and 5 shown on drawings above)
- 1 No. Schwegler 1FQ bat box will be wall mounted on the west gable to accommodate and promote bat activity (see location 4)
- Temporary bat boxes will be located in the adjacent barn during the construction phase. They must be installed at least 4 weeks prior to work commencing
- If any bats are found during work on site, work must cease immediately and a licensed bat surveyor or CCW should be contacted for advice on how to proceed
- If work on site does not commence within the next 1.5-2 years, an up to date bat survey will be required

ckplanning
 Chris Kimpton
 BA(HONS) MRTPI
 Chartered
 Town Planner
 01348 872352
 07899 614 3152

Andrew & Maris Makin
 Renovation of an Existing
 Former Farm Workers
 (Dwelling) Cottage to Create a
 Rural Enterprise Workers
 Dwelling
 Proposed Elevations
 Scale 1:100 Drawn by RC Date May 12

Job No. Drawing No. Rev.
 P03

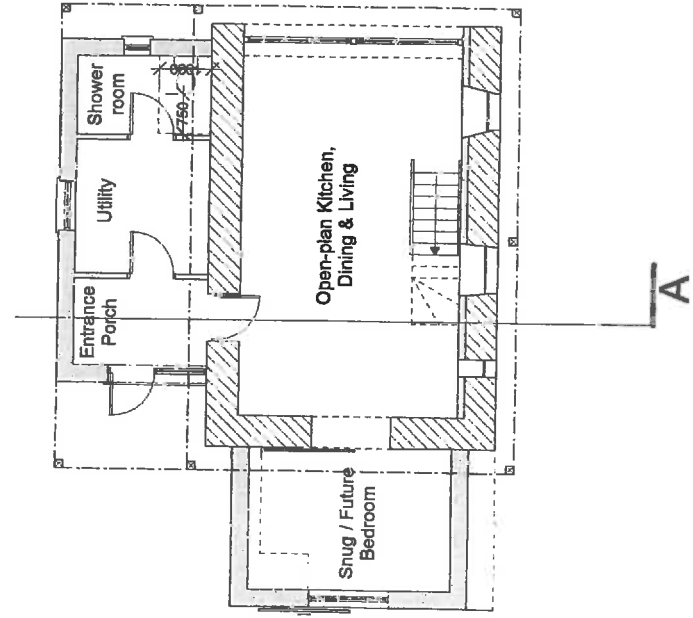

Proposed Ground Floor Plan

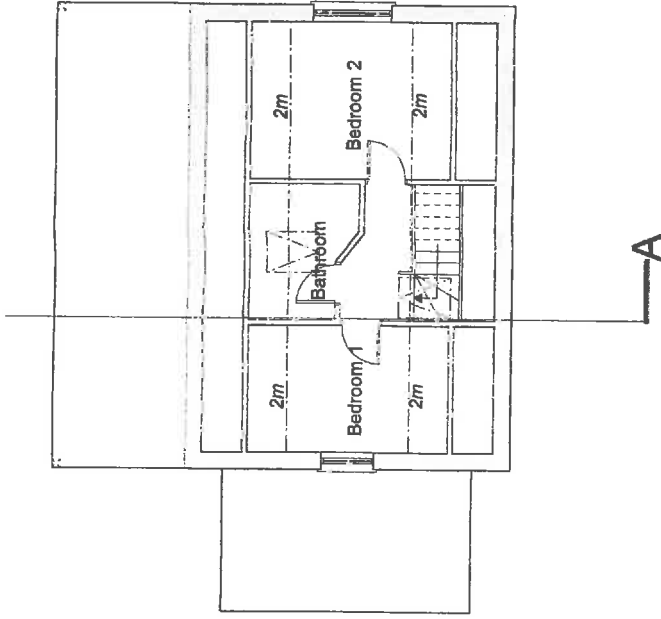

Proposed First Floor Plan

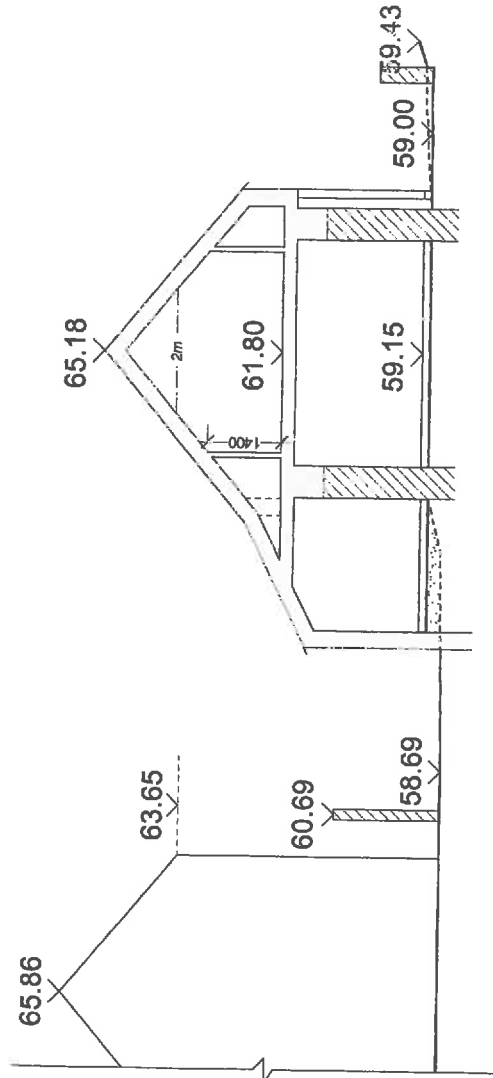

Proposed Section A-A

- Key:**
- Existing Wall
 - New Wall
 - Existing Site Levels to be altered
 - Existing Building Footprint

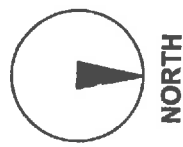

09 AUG 2012

12412

ckplanning
Chris Kimpson
BA(HONS) MPP 412
Chartered
Town Planner

01348 572352
0789 614 3152

Andrew & Maria Malin
Renovation of an Existing
Former Farm Workers (Dwelling)
Cottage to Create a Rural
Enterprise Workers Dwelling
Proposed Floor Plans &
Section A-A
Scale: 1:100 Date: May 12

Drawn by:	PKD
Checked by:	PKD



08 AUG 2012

2012 4 12

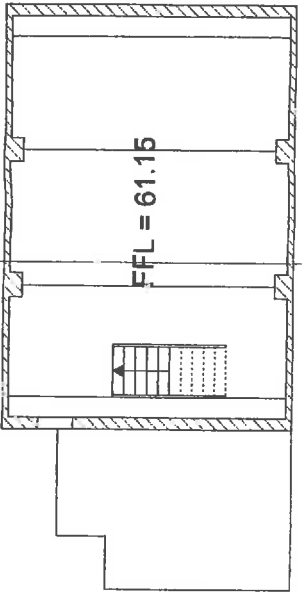

First Floor Plan

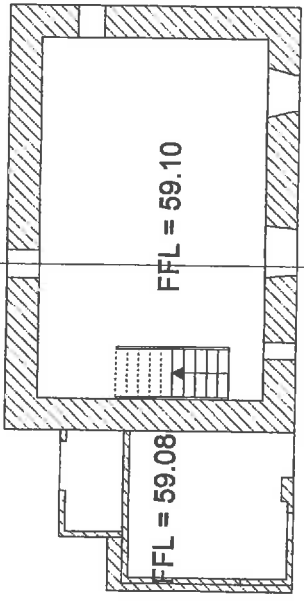

Ground Floor Plan

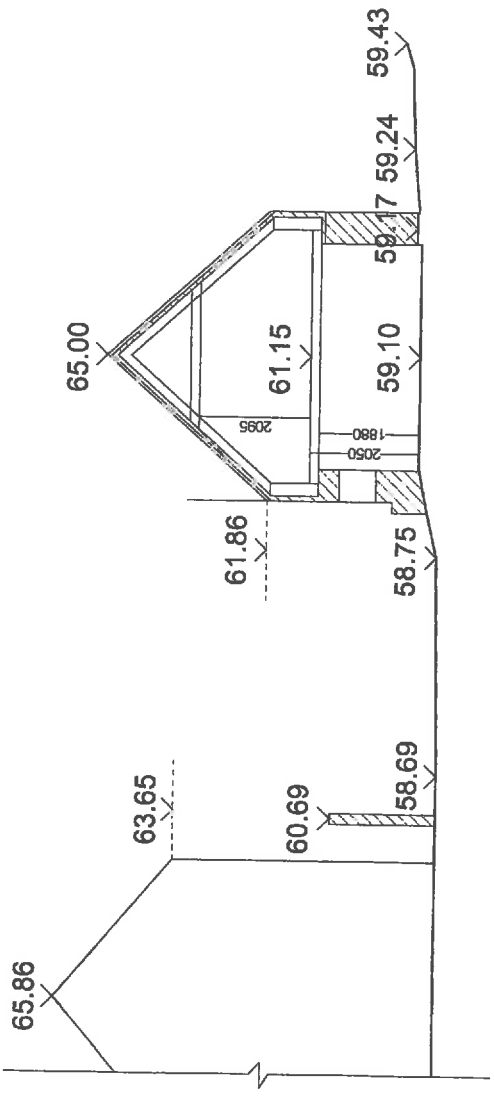
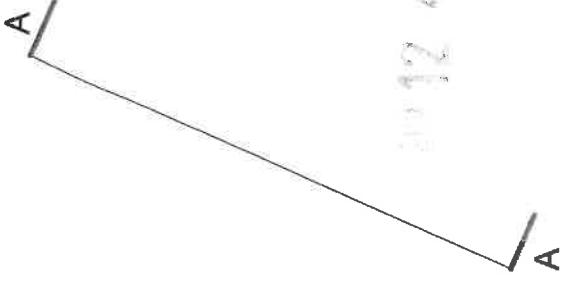

Section A-A

Site Plan Key: Section A-A
(1:200)

ckplanning
Chris Kimbush
BA(HONS) MCRPI
Chartered
Town Planner

013-88 872352
0789 614 3152

Renovation of an Existing
Former Farm Workers (Dwelling)
Cottage to Create a Rural
Enterprise Workers Dwelling
Existing Floor Plans &
Section A-A
Scale 1:100 Date May 12

Author: Andrew & Mattis Melehn
Date: May 12

East Aspect



West Aspect

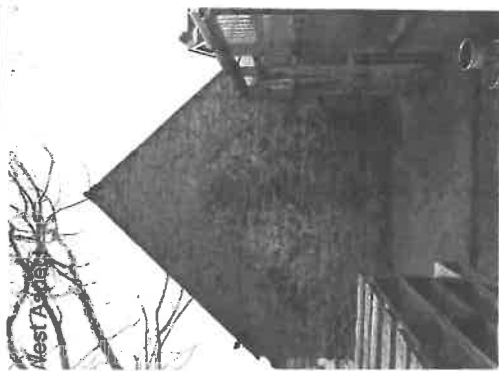

North Aspect



South Aspect

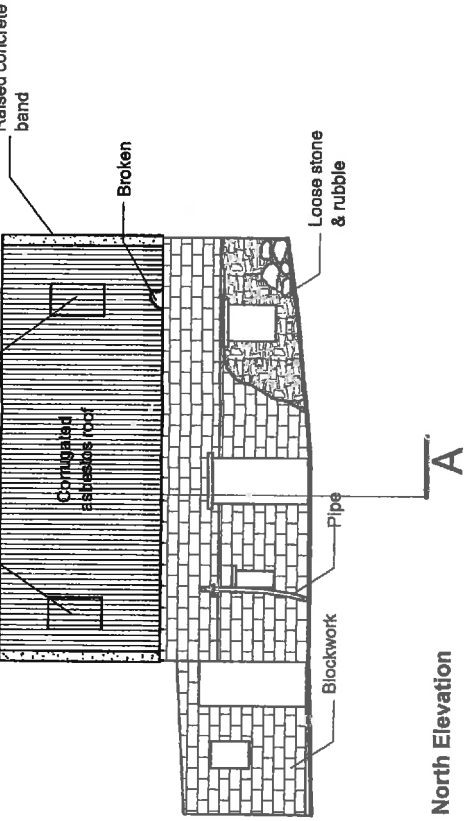
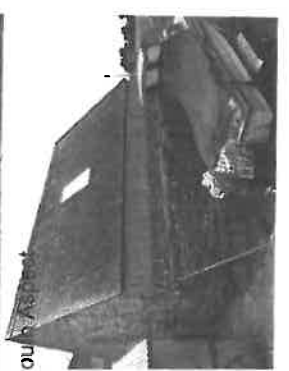

North Elevation

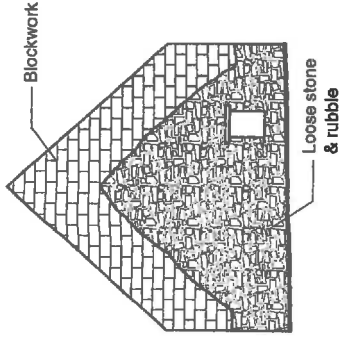

West Elevation

Window frames rotten

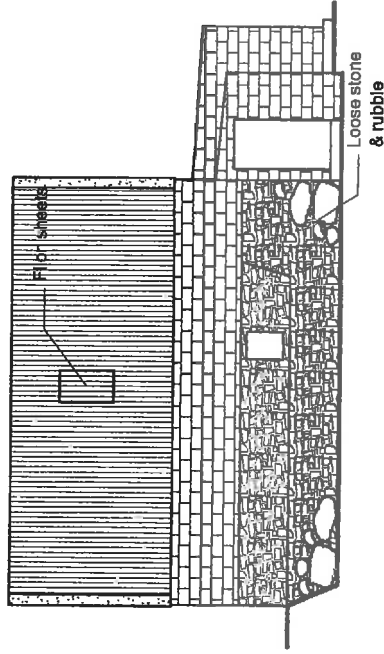

South Elevation

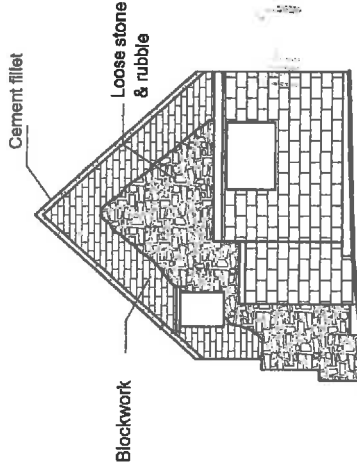

East Elevation

09 AUG 2012

12 x 12

Date: _____
 Drawn by: _____
 Checked by: _____
 Date: _____
 Scale: 1:100 Date: 12/05/12

ckplanning
 Chris Kimpton
 BA(HONS) MCPI
 Chartered
 Town Planner

01348 873352
 0789 614 3152

2005 THE CHARITABLE BUILDINGS ACT (PART 1)
 THIS DRAWING IS THE PROPERTY OF CKPLANNING LTD.
 NO PART OF THIS DRAWING IS TO BE REPRODUCED
 OR TRANSMITTED IN ANY FORM OR BY ANY MEANS
 WITHOUT THE WRITTEN PERMISSION OF CKPLANNING LTD.

Drawn: Andrew & Maris Mealin
 Renovation of an Existing
 Former Farm Workers (Dwelling)
 Cottage to Create a Rural
 Enterprise Workers Dwelling
 Drawing: Existing Elevations
 Date: 12/05/12 Scale: 1:100



NP/12/0412

New stone wall to form curtilage (lime rendered to match cottage)

Renovation of an Existing former farm workers (Dwelling) cottage to create a Rural Enterprise Dwelling

Access to existing garden to be provided by stone steps landscaped into existing hedgebank

Ground to be excavated upto the hedgebank and landscaped with a permeable surface of grass and gravel

Hedgebank to be retained as existing

Pen-Pant Farm House

Concrete yard

Gravelled Vehicle turning area

New ambulant disabled parking space and level non-granular access path to principle entrance

New septic tank to be provided for the discharge of foul waste

Surface Water to be discharged via the existing land drain

Gravel Access Track

A487

A487 Public Highway

1872/1

08 AUG 2012

ckplanning
Chris Kimpton
BA(HONS) MRTPI

Chartered
Town Planner

Andrew & Marla Malein
Renovation of an Existing
Former Farm Workers
(Dwelling) Cottage to Create a
Rural Enterprise Workers
Dwelling
Proposed Site Plan
Scale 1:500 Drawn By RC Date May 12

01348 872352
0789 614 3152

PO1

NORTH

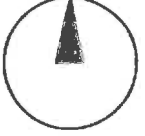

NP/12/0412

2002 50V 80

NP 12 4 12

Existing garden area

Existing former farm workers cottage

Concrete

Gravel

Hedgebank

Pen-Pant Farm Outbuildings

Pen-Pant Farm House

Concrete yard

Gravelled Vehicle turning area

Septic Tanks

Land Drain

Pen-Pant Farm Shop

Gravel Access Track

A487

A487 Public Highway

ckplanning
 Chris Kimpton
 BA(HONS) MRTPI
 Chartered
 Town Planner

01348 872352
 0789 614 3152

For: Andrew & Marie Malein
 Renovation of an Existing
 Former Farm Workers (Dwelling)
 Cottage to Create a Rural
 Enterprise Workers Dwelling

Existing Site Plan

Scale: 1:500
 Date: May 12

Job No:	Drawing No:	Rev:
	S02	

